

## GET4™ Super Ion Air Knife™

Powerful static eliminator prevents jamming, tearing, shocks and dust up to 20' away!

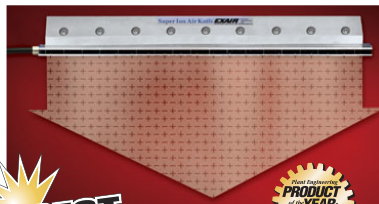

Uses The Super Air Knife

- ✓ Low Air Consumption!
- ✓ Surprisingly Quiet!
- ✓ Uniform Airflow!
- ✓ End and Bottom Air Inlets!

### What Is The GET4 Super Ion Air Knife?

EXAIR's Gen4 Super Ion Air Knife offers 34% improved performance at low pressures allowing you to achieve the same or better results, which saves compressed air and money. Gen4 Super Ion Air Knives remove static electricity from plastics, webs, sheet stock and other product surfaces where tearing, jamming or hazardous shocks are a problem. The laminar sheet of air sweeps surfaces clean of static, particulate, dust and dirt. Production speeds, product quality, and surface cleanliness can improve dramatically.



The Gen4 Super Ion Air Knife eliminates the static charge on labels being applied to PET soft drink bottles.

### Why The GET4 Super Ion Air Knife?

The Gen4 Super Ion Air Knife floods an area or surface with static eliminating ions - up to 20 feet (6.1m) away. A uniform airflow across its length will not cause misalignments to critical surfaces such as webs. Force can be adjusted from a "blast" to a "breeze". The Gen4 Super Ion Air Knife is electrically powered, is shockless and has no moving parts. It also requires only 3.7 SCFM of compressed air per foot of length at 5 PSIG (105 SLPM per 300mm of length at 0.3 BAR). Sound level is surprisingly quiet at 50 dBA for most applications

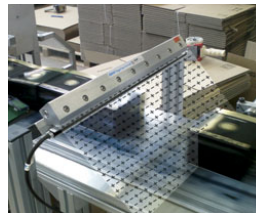

The Model 112118 18" (457mm) Gen4 Super Ion Air Knife System eliminates dust from body care products prior to sealing the boxes in cellophane.

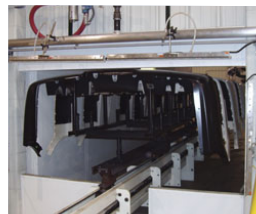

Bumpers, car bodies and fascia are cleaned of dust and fibers prior to painting.

#### Applications

- Web cleaning
- Molding machinery
- Sheeters and trimmers
- Cleaning parts
- Pre-paint dust removal
- Shrink wrappers
- Package cleaning
- Bag opening/ fill operations
- Printing equipment

#### Advantages

- Up to 34% improved performance
- Rugged metal armored and electromagnetically shielded cable
- Integrated ground eliminates additional ground connection
- Durable stainless steel connections to Power Supply
- Low air consumption
- Uniform airflow across entire length
- Quiet
- Effective up to 20 feet (6.1m)
- Shockless, non-radioactive
- Compact, rugged, easy to install
- Unlimited system lengths of uninterrupted airflow
- Low maintenance
- UR/CE
- EMC Compliant
- Modular power supply cable eases connections and routing

## How The GET4 Super Ion Air Knife Works

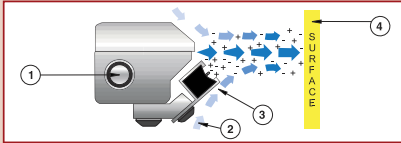

Compressed air flows through an inlet (1) into the plenum chamber of the Gen4 Super Ion Air Knife. The flow is directed to a precise, slotted orifice. As the primary airflow exits, it creates a uniform sheet of air across the entire length that immediately pulls in surrounding room air (2). An electrically powered Gen4 Ionizing Bar (3) fills the curtain of air with positive and negative charges. The airstream delivers these static eliminating ions to the product surface (4) where it instantly neutralizes static and cleans off dust and other particulates.

## Added Features

- Compressed air inlets are provided on each end and the bottom of the Gen4 Super Ion Air Knife. Unlimited lengths available up to 119" (3,02m).
- Thicker shims can be installed easily if additional hard-hitting velocity is required.
- Primary air does not impact any surface of the Gen4 Super Ion Air Knife which keeps the sound level low.
- Insertion molded emitter points eliminate potential dirt accumulation that could degrade performance or eventually short the ionizing bar.
- Emitter points are sharp, durable stainless steel.
- The high voltage cable is armored to resist cuts and abrasion and has integral grounding, which prevents an additional connection. The threaded bayonet connector is fully assembled and ready to use.
- Electromagnetically shielded cable protect sensitive electronics.
- Gen4 Super Ion Air Knife Kits, which include all components necessary for operation, are available.

## GET4 Super Ion Air Knife Performance

Pressure Supply		Air Consumption*		Sound Level	Dissipates 5kV**	
PSIG	BAR	SCFM	SLPM	dBA	SECONDS	SECONDS
5	0.3	3.7	105	39	0.40	
10	0.7	5.5	156	51	0.33	
20	1.4	13.2	372	57	0.26	
40	2.8	20.4	576	61	0.23	
60	4.1	27.6	780	65	0.21	
80	5.5	37.8	934	69	0.20	
100	6.9	42.0	1,188	72	0.18	

\* per foot (305mm) of length

\*\* 6" (152mm) from target

For airflow pattern, see Super Air Knife page 22

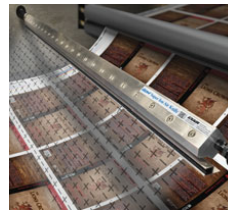

The Model 112048 48" (1219mm) Gen4 Super Ion Air Knife neutralizes the static electricity and cleans the surface of the paper.

Static Eliminators

## GET4 Super Ion Air Knife Dimensions

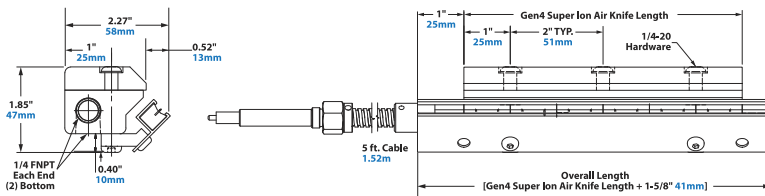

## Enhanced Performance and Reliability

Gen4 Ionizing Bars are most effective with an air delivery system. That allows the static eliminating ions to reach farther with greater coverage. Gen4 Ionizing Bars are less effective without an air delivery system. When used by itself, a bar must be mounted within 4 inches of the charged surface to fully neutralize it. This close mounting is impossible when the static is generated in confined areas of a machine. Ion coverage is minimal on oddly configured parts or when high production speeds are involved.

The right type of air delivery is critical. Blowers produce an uneven, turbulent airstream that can cause the positive and negative ions to recombine before hitting the charged material. They are large, suffer mechanical wear and provide limited airflow control. The compact Gen4 Super Ion Air Knife uses a small amount of compressed air to produce a balanced, laminar sheet of air to carry the ions to the charged surface, even when it is far away. Flow and force are easily controlled and there are no moving parts to wear out.

# GEN4™ Super Ion Air Knife

## GEN4 Super Ion Air Knife Specifications

The Gen4 Super Ion Air Knife is available in standard lengths of 3", 6", 9", 12", 18", 24", 30", 36", 42", 48", 54", 60", 72", 84", 96" and 108" (76, 152, 229, 305, 457, 610, 762, 914, 1067, 1219, 1372, 1524, 1829, 2134, 2438 and 2743mm). **Special lengths and unlimited system lengths are available (please contact our factory).**

A 5' (1.52m) armored and electromagnetically shielded power cable with ground and assembled bayonet connector are included.

**EXAIR Model 7960 or 7961 Gen4 Power Supply (5kV) is required for bar operation.** Power supplies are equipped with a modular 6' (1.83m) power cord, lighted power switch integrated fuse on the primary and (2) or (4) high voltage outlets.

**Certifications:** Gen4 Ionizing Bars and Gen4 Power Supplies are UL Component Recognized to U.S. and Canadian safety standards, and are CE and RoHS compliant.

**Compressed Air:** 1/4 NPT inlets are provided on each end and the bottom.

**Electrical:** For use with Model 7960 or 7961 5 kVrms, 5 milliamperes (max.) power supply.

**Electrical Hazard:** Gen4 Ionizing Bars are shockless (less than 40 microamperes short circuited).

**Do not use near flammable materials or gases.**

### Materials of Construction:

**Metal Parts:** Aluminum

**Plastic Parts:** UL rated 94 HB

**Emitters:** Stainless Steel

**Maximum Ambient Temperature:** 165°F (74°C)

**Shims:** Thicker shims can be installed easily if additional hard-hitting velocity is required. For more information, see "shim sets" on page 23.

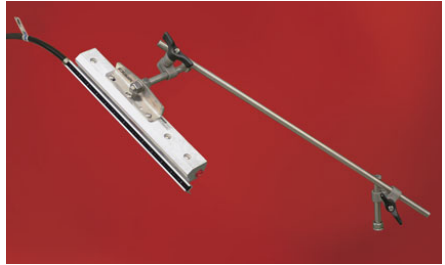

Model 9060 Universal Air Knife Mounting System provides secure, precise positioning for the Gen4 Super Ion Air Knife. See page 27 for details.



Static Eliminators

## Static Meter

# Static Meter

## Locate the source of the static problem!



### Digital Static Meter Locates The Source!

The Model 7905 Digital Static Meter allows easy one-hand static measurements. In most cases, the highest voltage reading will indicate the source of the static problem. Sensitive and responsive, it indicates the surface voltage and polarity on objects up to  $\pm 20$  kV when measured one inch (25mm) away.

The Digital Static Meter features a push button "hold" for readings, a low battery indicator and an automatic "power off". A "zero" button to zero the instrument ensures an accuracy of  $\pm 5\%$  of the reading when it is one inch (25mm) from the charged surface.



The Model 7905 Digital Static Meter comes complete with a hard-shell plastic case and a 9 volt battery. Certification of the accuracy and calibration traceable to NIST (National Institute of Standards and Technology) is also included. Calibration is available.

## Dust Removal From Car Bodies

**The Problem:** Car bodies are primer coated, then sanded before entering the paint booth. Priming dust, attracted to the car body by a static charge, creates imperfections that are captured and magnified in the painting process.

**The Solution:** An “archway” of **Model 112024 24" (610mm) Gen4 Super Ion Air Knives** was installed **upstream of the paint booth**. As the car bodies pass through, a **high velocity sheet of ionized air neutralizes the static charge to release the dust and blow it toward a collection system.**

**Comment:** Non-turbulent airflow was the reason this cleaning system worked so well. The compact Gen4 Super Ion Air Knife has the ability to move the bulk of the static eliminating ions to the car surface. It can be adjusted from a gentle breeze of air to a pounding blast, with instant “on/off” capability. Uniform airflow across the entire length assures that all car body surfaces are neutralized and dust free. Best of all, the Gen4 Super Ion Air Knife is easy on the compressed air system and workers' ears. They use much less compressed air than standard blowoffs and are around 69 dBA in most applications.

(6) Model 112024  
24" (610mm) Gen4 Super Ion Air Knives (3) Model 7960 Gen4  
Power Supplies

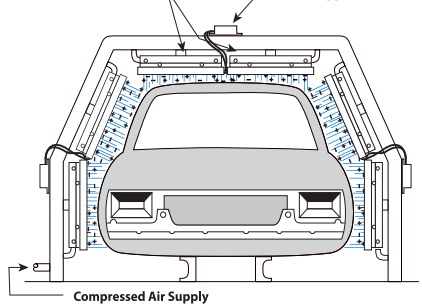

EXAIR's EFC (shown on page 7) is an electronic flow control for compressed air. It can sense when there is no car present and will automatically turn off the compressed air until the next car is moved into position. It is a perfect addition to this type of application.

## A Manufacturer Of Perfumes And Fragrances Eliminates Dust From Their Packages

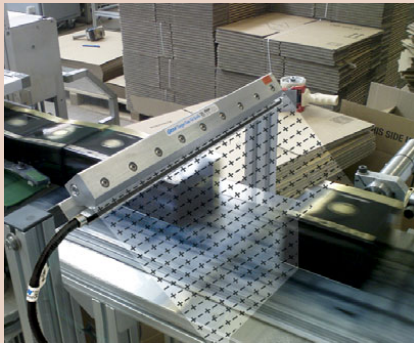

**The Problem:** A manufacturer of perfumes and fragrances had a problem with the packaging of their fine perfumes. The conveyor belt used to transport the boxes to the cellophane sealer rubbed against the box surface and induced a sizable static electricity charge on it that made it a "dust magnet". The cardboard dust and particulates

in their facility would land on the perfume boxes that were sent through the cellophane sealer. The trapped dust gave a poor appearance to the finished package. The company refused to let the boxes with the poor appearance leave their facility. Attempts to clean them using ordinary air guns produced poor results.

**The Solution:** The company installed a **Model 112018 18" (457mm) Gen4 Super Ion Air Knife** prior to the box entering the sealer. The charged surface was completely neutralized with the ionized airflow and the dust and particulates were blown away. The cellophane covered boxes were perfectly clean.

**Comment:** EXAIR's Gen4 Super Ion Air Knife is used for applications just like these where appearance is vital to the sale of the product. The Gen4 Super Ion Air Knife is commonly used for pre-package cleaning, bag opening and filling operations, cleaning automobile bodies prior to painting, web cleaning, as well as eliminating jams, tears and those painful static electricity shocks.

# GEN4™ Super Ion Air Knife

## Cleaning Porcelain Dishes Prior To Glazing



**The Problem:** A manufacturer of fine porcelain dinnerware products had a problem with dust ruining the finish on their dishes. Dust particles were adhering to the surface of the dishes which created imperfections that were greatly magnified once the glaze was applied. Prior to glazing, they made attempts to blow the dust particles away using ordinary air nozzles which had little effect, if any. There were abundant rejects.

**The Solution:** They installed (3) **Model 112018 18" (457mm) Gen4 Super Ion Air Knives** to surround each dish, neutralize the static charge and remove the dust particles. Any airborne particulate was immediately vacuumed away by their dust collection system. The dishes were completely smooth to the touch with no imperfections.

**Comment:** A similar problem used to plague automotive manufacturers. The static charge generated by the automobile body tack off operation would cause the car body to attract stray particles of priming dust. Once the paint hits a dust particle, it sticks out like a sore thumb and ruins an otherwise perfect robotic paint job. The **Gen4 Super Ion Air Knife** is ideal here since it neutralizes the charge and blows the dust away (in the direction of their dust collection system). To minimize compressed air use for these applications, we recommend the use of an EXAIR EFC Electronic Flow Control that automatically turns off the compressed air when no part is present.

### GEN4 Super Ion Air Knife Models

**Gen4 Super Ion Air Knife** - includes the Super Air Knife and Gen4 Ionizing Bar assembly.

**Gen4 Super Ion Air Knife Systems** - include a Gen4 Super Ion Air Knife and Model 7960 Gen4 Power Supply (115V, 230V, 50/60 Hz)

**Gen4 Super Ion Air Knife Kits** - include a Gen4 Super Ion Air Knife, Model 7960 Gen4 Power Supply, shim set, filter separator and pressure regulator (with coupler).

**Gen4 Deluxe Super Ion Air Knife Kits** - include a Gen4 Super Ion Air Knife, Model 7960 Gen4 Power Supply, EFC, Universal Mounting System, shim set, filter separator and pressure regulator (with coupler).

Length	Gen4 Super Ion Air Knife Model	Gen4 Super Ion Air Knife Systems Model	Gen4 Super Ion Air Knife Kits Model	Gen4 Deluxe Super Ion Air Knife Kits Model
3" (76mm)	112003	112103	112203	112203DX
6" (152mm)	112006	112106	112206	112206DX
9" (229mm)	112009	112109	112209	112209DX
12" (305mm)	112012	112112	112212	112212DX
18" (457mm)	112018	112118	112218	112218DX
24" (610mm)	112024	112124	112224	112224DX
30" (762mm)	112030	112130	112230	112230DX
36" (914mm)	112036	112136	112236	112236DX
42" (1067mm)	112042	112142	112242	112242DX
48" (1219mm)	112048	112148	112248	112248DX
54" (1372mm)	112054	112154	112254	112254DX
60" (1524mm)	112060	112160	112260	112260DX
72" (1829mm)	112072	112172	112272	112272DX
84" (2134mm)	112084	112184	112284	112284DX
96" (2438mm)	112096	112196	112296	112296DX
108" (2743mm)	112108	112108	1122108	1122108DX



Kits include the Gen4 Super Ion Air Knife, shim set, Model 7960 Gen4 Power Supply, filter separator and pressure regulator (with coupler).

### Universal Air Knife Mounting System

EXAIR's Universal Air Knife Mounting System allows easy positioning of all EXAIR Air Knives. See page 27 for details.



## GEN4 Long Super Ion Air Knives

EXAIR offers Long Gen4 Super Ion Air Knives in 60" (1524mm), 72" (1829mm), 84" (2134mm), 96" (2438mm) and 108" (2743mm) lengths that are shipped fully assembled. All components have been properly sized to obtain the best performance from the Gen4 Super Ion Air Knife.



This 96" Long Gen4 Super Ion Air Knife cleans an acrylic sheet before protective wrap is applied.

## GEN4 Super Ion Air Knife Models with Plumbing Kit

**Gen4 Super Ion Air Knife with Plumbing Kit** - includes Super Air Knife, plumbing kit and Gen4 Ionizing Bar installed.

**Gen4 Super Ion Air Knife Systems with Plumbing Kit** - include Super Air Knife, plumbing kit and Gen4 Ionizing Bar installed. Includes Model 7960 Gen4 Power Supply (115V, 230V, 50/60Hz).

**Gen4 Super Ion Air Knife Kits with Plumbing Kit** - include Super Air Knife, plumbing kit and Gen4 Ionizing Bar installed. Also includes Model 7960 Gen4 Power Supply (115V, 230V, 50/60Hz), shim set, filter separator and pressure regulator (with coupler).

Length	Gen4 Super Ion Air Knife Model	Gen4 Super Ion Air Knife Systems Model	Gen4 Super Ion Air Knife Kits Model
24" (610mm)	112024PKI	112124PKI	112224PKI
30" (762mm)	112030PKI	112130PKI	112230PKI
36" (914mm)	112036PKI	112136PKI	112236PKI
42" (1067mm)	112042PKI	112142PKI	112242PKI
48" (1219mm)	112048PKI	112148PKI	112248PKI
54" (1372mm)	112054PKI	112154PKI	112254PKI
60" (1524mm)	112060PKI	112160PKI	112260PKI
72" (1829mm)	112072PKI	112172PKI	112272PKI
84" (2134mm)	112084PKI	112184PKI	112284PKI
96" (2438mm)	112096PKI	112196PKI	112296PKI
108" (2743mm)	112108PKI	1121108PKI	1122108PKI

Special length Gen4 Super Ion Air Knives and unlimited system lengths are available.



Order EXAIR's EFC™ electronic flow control to minimize compressed air use. See page 7 for details.



Static Eliminators

## Accessories and Components

Model #	Description	Model #	Description
7960	2 Outlet Selectable Voltage Gen4 Power Supply (115V, 230V, 50/60Hz)	7905	Static Meter
7961	4 Outlet Selectable Voltage Gen4 Power Supply (115V, 230V, 50/60Hz)	9001	Auto Drain Filter Separator, 3/8 NPT, 65 SCFM (1,841 SLPM)
8003	3" (76mm) Gen4 Ionizing Bar Only	9032	Auto Drain Filter Separator, 1/2 NPT, 90 SCFM (2,549 SLPM)
8006	6" (152mm) Gen4 Ionizing Bar Only	9002	Auto Drain Filter Separator, 3/4 NPT, 220 SCFM (6,230 SLPM)
8009	9" (229mm) Gen4 Ionizing Bar Only	9066	Auto Drain Filter Separator, 1-1/4 NPT, 400 SCFM (11,327 SLPM)
8012	12" (305mm) Gen4 Ionizing Bar Only	9005	Oil Removal Filter, 3/8 NPT, 15-37 SCFM (425-1,048 SLPM)
8018	18" (457mm) Gen4 Ionizing Bar Only	9006	Oil Removal Filter, 3/4 NPT, 50-150 SCFM (1,416-4,248 SLPM)
8024	24" (610mm) Gen4 Ionizing Bar Only	9008	Pressure Regulator with Gauge, 1/4 NPT, 50 SCFM (1,416 SLPM)
8030	30" (762mm) Gen4 Ionizing Bar Only	9033	Pressure Regulator with Gauge, 1/2 NPT, 100 SCFM (2,832 SLPM)
8036	36" (914mm) Gen4 Ionizing Bar Only	9009	Pressure Regulator with Gauge, 3/4 NPT, 220 SCFM (6,230 SLPM)
8042	42" (1067mm) Gen4 Ionizing Bar Only	9067	Pressure Regulator with Gauge, 1-1/4 NPT, 600 SCFM (16,990 SLPM)
8048	48" (1219mm) Gen4 Ionizing Bar Only	9020	Solenoid Valve, 120V, 50/60Hz, 1/4 NPT, 40 SCFM (1,133 SLPM)
8054	54" (1372mm) Gen4 Ionizing Bar Only	9034	NEMA 4/4X Solenoid Valve, 120V, 50/60Hz, 1/2 NPT, 100 SCFM (2,832 SLPM)
8060	60" (1524mm) Gen4 Ionizing Bar Only	9035	NEMA 4/4X Solenoid Valve, 240V, 50/60Hz, 1/2 NPT, 100 SCFM (2,832 SLPM)
8072	72" (1829mm) Gen4 Ionizing Bar Only	9036	NEMA 4/4X Solenoid Valve, 120V, 50/60Hz, 3/4 NPT, 200 SCFM (5,664 SLPM)
8084	84" (2134mm) Gen4 Ionizing Bar Only	9037	NEMA 4/4X Solenoid Valve, 240V, 50/60Hz, 3/4 NPT, 200 SCFM (5,664 SLPM)
8096	96" (2438mm) Gen4 Ionizing Bar Only	9065	NEMA 4/4X Solenoid Valve, 24VDC, 50/60Hz, 1 NPT, 350 SCFM (9,911 SLPM)
80108	108" (2743mm) Gen4 Ionizing Bar Only		